



MODULAR PROMOTIONAL SYSTEM

ASSEMBLY INSTRUCTION

PROMO 1[®]

PROMO 1

Do you know that **PROMO 1** is the only promotional system you really need?

Thank you for choosing Promo 1. We hope that our product will meet your expectations and will provide you with an effective marketing tool. Next pages contain ready-to-use conceptions of stands, which you can set up with Promo 1.

Any questions, any doubts? Feel free to visit our site: www.promo-1.eu. Our representatives are always at your disposal as well.

We wish you every success in marketing activity
Promo 1 Team



HOW TO FAST AND EASILY SET UP A PROMOTIONAL POINT WITH PROMO 1 ?

Every configuration is available in the blink of an eye thanks to tool-free assembly and magnetic graphic panels.

01— MOBILE AND EASILY TRANSPORTABLE

Promo 1 is a system of light, robust aluminium frames, which you can carry on a convenient trolley as well as in an estate car.



02— INTUITIVE, TOOL-FREE ASSEMBLY

Promo 1 frames can be connected without any tools thanks to special connectors. You can equip the system with a range of accessories and easily expand it whenever needed.



03— EXCHANGEABLE GRAPHIC PANELS

Thanks to exchangeable, magnetic graphic panels you can instantly transform your promotional point whenever it will be needed. Remember that only graphic panels require replacement.



CONFIGURATIONS OVERVIEW



—01



—02



—03



—07



—08



—09



—13



—14



—15



—19



—20



—21



—04



—05



—06



—10



—11



—12



—16



—17



—18



—22



—23



—24

CONFIGURATION — 01

TECHNICAL INFO

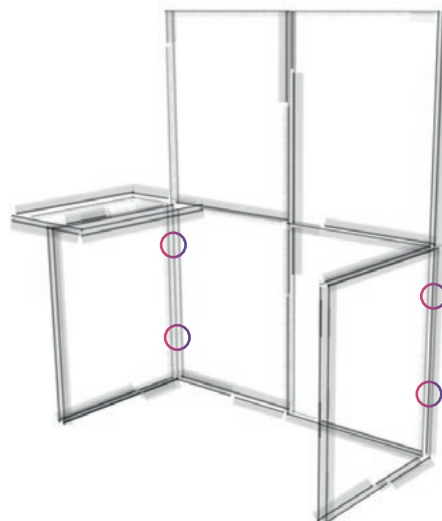

PROMO 1 FEATURES



Assemblable by
one person



Reusable



Assemblable in
15 minutes



Fits into an
estate car



Tool-free assembly

PROMOTIONAL POINT SKETCH

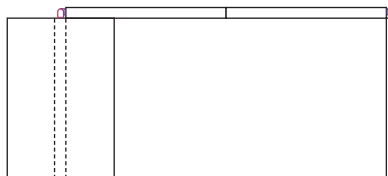

CONFIGURATION — 02



TECHNICAL INFO

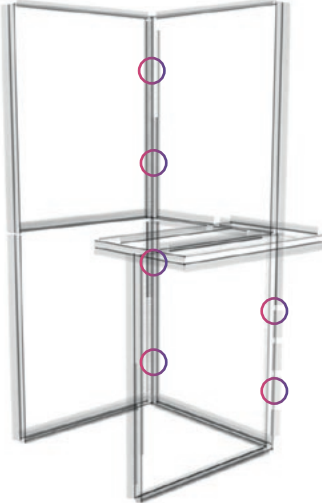

PROMO 1 FEATURES

 Assemblable by one person

 Reusable

 Assemblable in 15 minutes

 Fits into an estate car

 Tool-free assembly

PROMOTIONAL POINT SKETCH

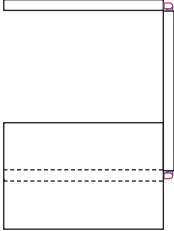

CONFIGURATION — 03

TECHNICAL INFO

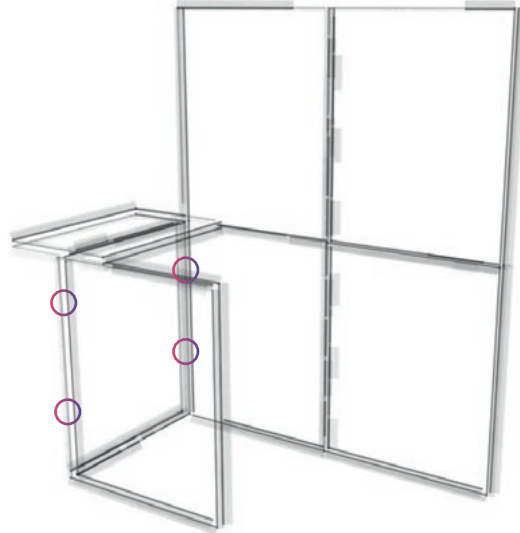

PROMO 1 FEATURES



Assemblable by
one person



Reusable



Assemblable in
15 minutes



Fits into an
estate car



Tool-free assembly

PROMOTIONAL POINT SKETCH

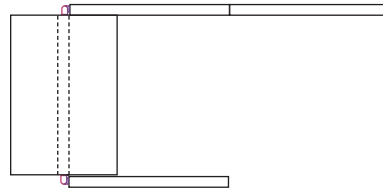

CONFIGURATION — 04

TECHNICAL INFO

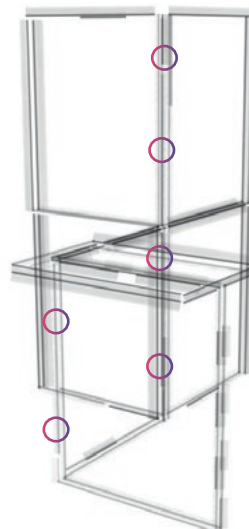

PROMO 1 FEATURES



Assemblable by
one person



Reusable



Assemblable in
15 minutes



Fits into an
estate car



Tool-free assembly

PROMOTIONAL POINT SKETCH

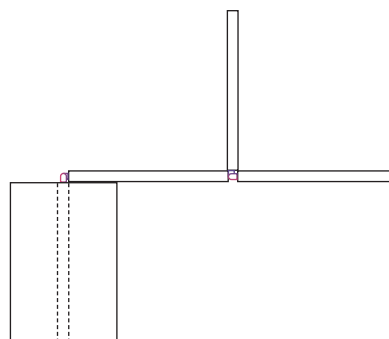

CONFIGURATION — 05

TECHNICAL INFO

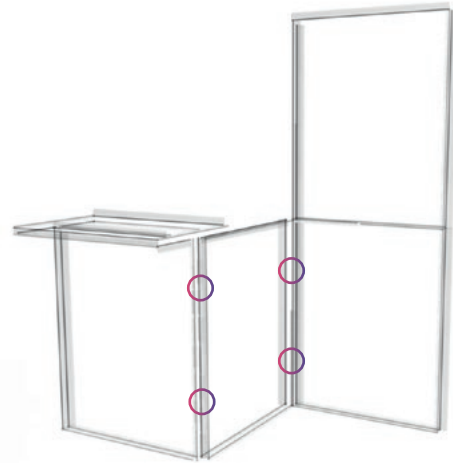

PROMO 1 FEATURES



Assemblable by
one person



Reusable



Assemblable in
15 minutes



Fits into an
estate car



Tool-free assembly

PROMOTIONAL POINT SKETCH

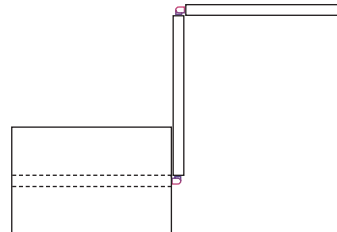

CONFIGURATION — 06

TECHNICAL INFO

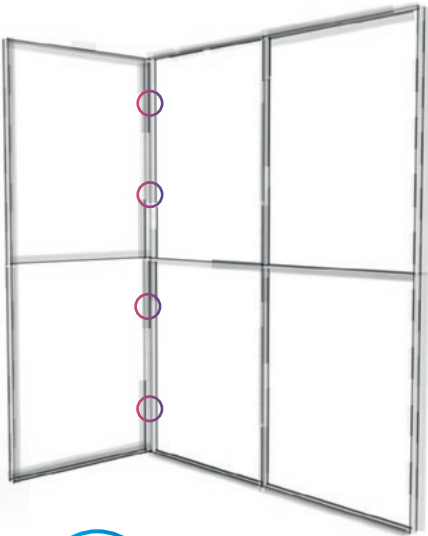

PROMO 1 FEATURES



Assemblable by one person



Reusable



Assemblable in 15 minutes



Fits into an estate car



Tool-free assembly

PROMOTIONAL POINT SKETCH



CONFIGURATION — 07

TECHNICAL INFO

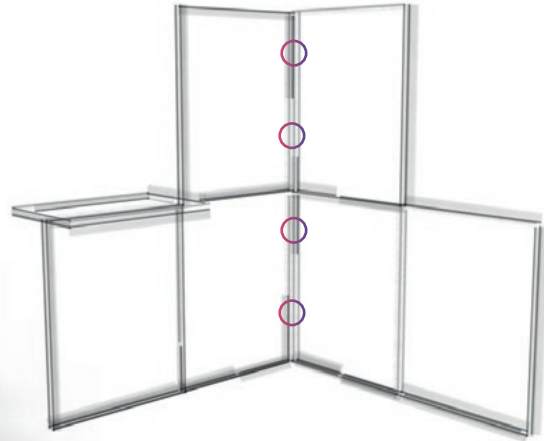

PROMO 1 FEATURES



Assemblable by one person



Reusable



Assemblable in 15 minutes



Fits into an estate car



Tool-free assembly

PROMOTIONAL POINT SKETCH

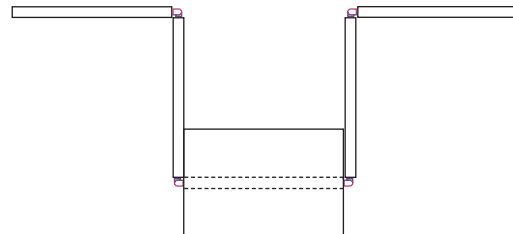

CONFIGURATION — 08

TECHNICAL INFO

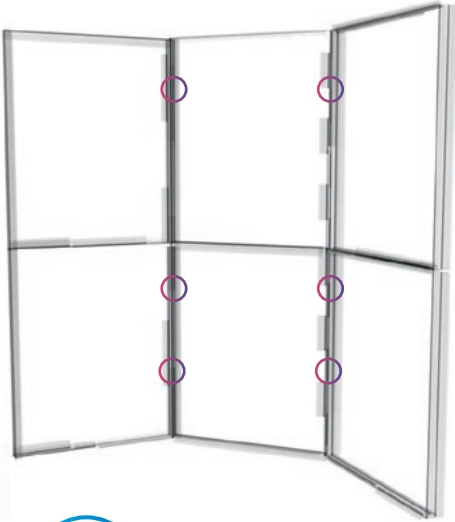

PROMO 1 FEATURES

 Assemblable by one person

 Reusable

 Assemblable in 15 minutes

 Fits into an estate car

 Tool-free assembly

PROMOTIONAL POINT SKETCH



CONFIGURATION — 09

TECHNICAL INFO

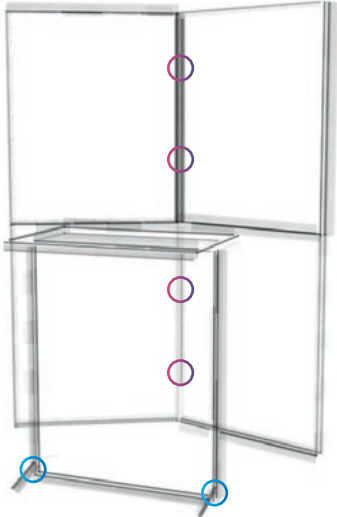

PROMO 1 FEATURES

 Assemblable by one person

 Reusable

 Assemblable in 15 minutes

 Fits into an estate car

 Tool-free assembly

PROMOTIONAL POINT SKETCH

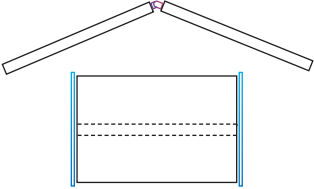

CONFIGURATION — 10

TECHNICAL INFO

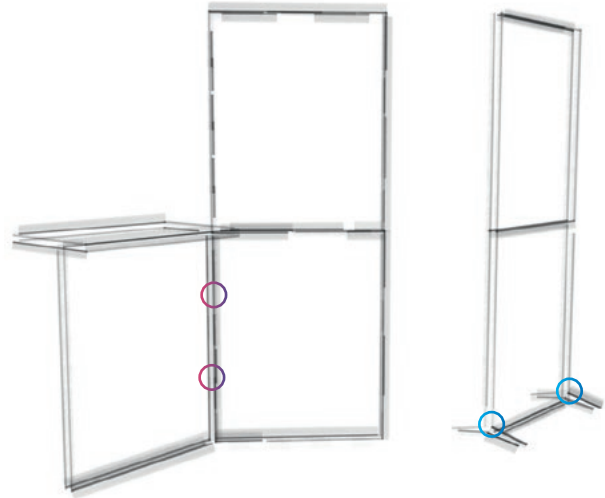

PROMO 1 FEATURES



Assemblable by one person



Reusable



Assemblable in 15 minutes



Fits into an estate car



Tool-free assembly

PROMOTIONAL POINT SKETCH

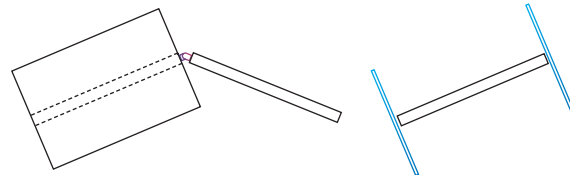

CONFIGURATION — 11

TECHNICAL INFO

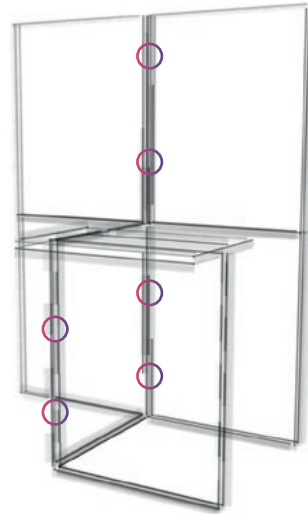

PROMO 1 FEATURES



Assemblable by
one person



Reusable



Assemblable in
15 minutes



Fits into an
estate car



Tool-free assembly

PROMOTIONAL POINT SKETCH

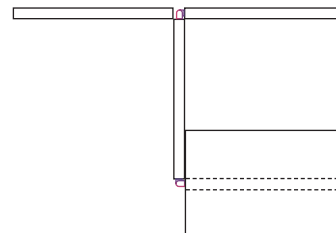

CONFIGURATION — 12

TECHNICAL INFO

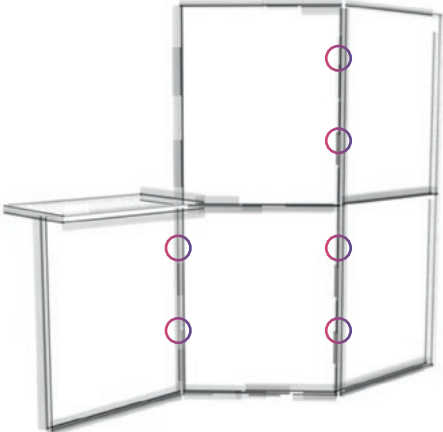

PROMO 1 FEATURES

 Assemblable by one person

 Reusable

 Assemblable in 15 minutes

 Fits into an estate car

 Tool-free assembly

PROMOTIONAL POINT SKETCH

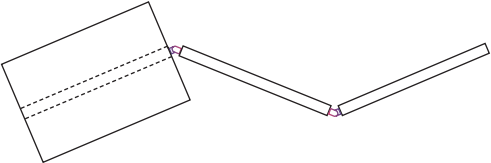

CONFIGURATION — 13

TECHNICAL INFO

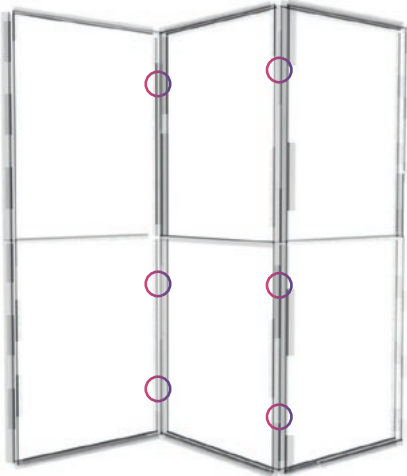

PROMO 1 FEATURES

 Assemblable by one person

 Reusable

 Assemblable in 15 minutes

 Fits into an estate car

 Tool-free assembly

PROMOTIONAL POINT SKETCH

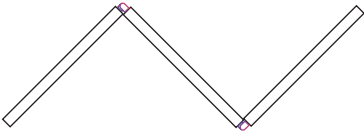

CONFIGURATION — 14

TECHNICAL INFO

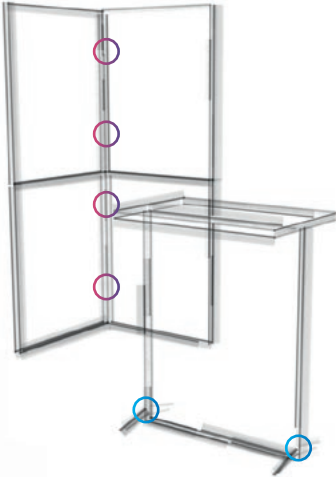

PROMO 1 FEATURES

 Assemblable by one person

 Reusable

 Assemblable in 15 minutes

 Fits into an estate car

 Tool-free assembly

PROMOTIONAL POINT SKETCH

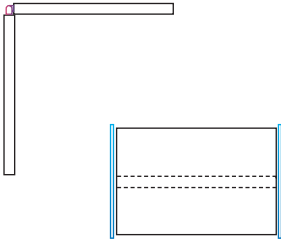

CONFIGURATION — 15



TECHNICAL INFO



PROMO 1 FEATURES



Assemblable by
one person



Reusable



Assemblable in
15 minutes



Fits into an
estate car



Tool-free assembly

PROMOTIONAL POINT SKETCH

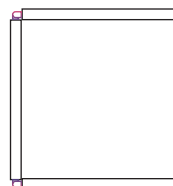

CONFIGURATION — 16

TECHNICAL INFO



PROMO 1 FEATURES



Assemblable by one person



Reusable



Assemblable in 15 minutes



Fits into an estate car



Tool-free assembly

PROMOTIONAL POINT SKETCH

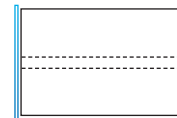

CONFIGURATION — 17



TECHNICAL INFO



PROMO 1 FEATURES



Assemblable by one person



Reusable



Assemblable in 15 minutes



Fits into an estate car



Tool-free assembly

PROMOTIONAL POINT SKETCH



CONFIGURATION — 18

TECHNICAL INFO

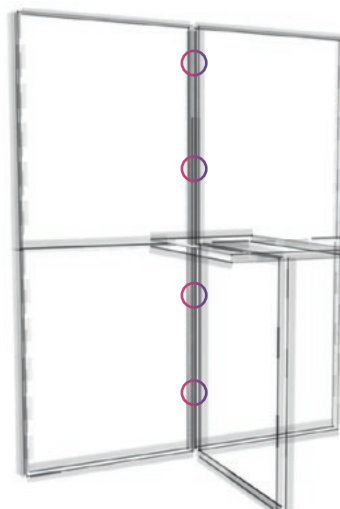

PROMO 1 FEATURES



Assemblable by
one person



Reusable



Assemblable in
15 minutes



Fits into an
estate car



Tool-free assembly

PROMOTIONAL POINT SKETCH

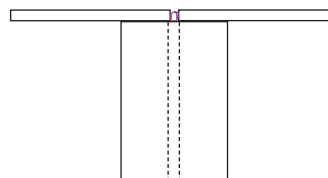

CONFIGURATION — 19



TECHNICAL INFO



PROMO 1 FEATURES

 Assemblable by one person

 Reusable

 Assemblable in 15 minutes

 Fits into an estate car

 Tool-free assembly

PROMOTIONAL POINT SKETCH

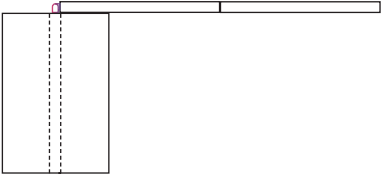

CONFIGURATION — 20

TECHNICAL INFO

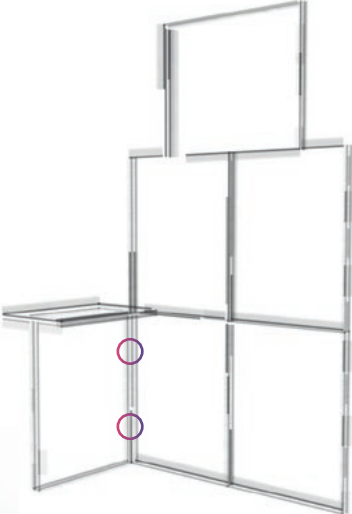

PROMO 1 FEATURES

 Assemblable by one person

 Reusable

 Assemblable in 15 minutes

 Fits into an estate car

 Tool-free assembly

PROMOTIONAL POINT SKETCH

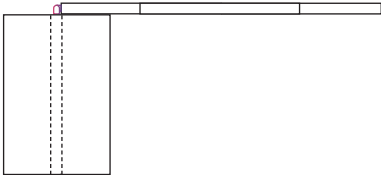

CONFIGURATION — 21

TECHNICAL INFO

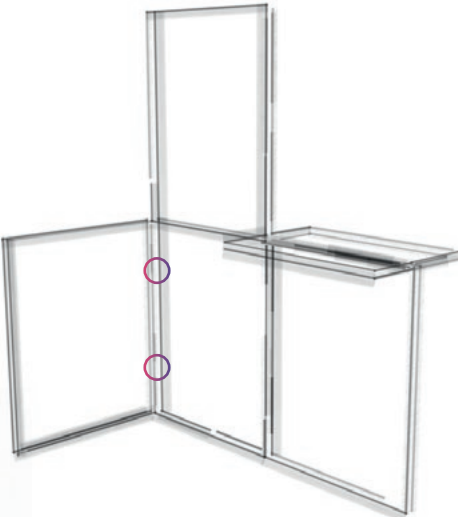

PROMO 1 FEATURES

 Assemblable by one person

 Reusable

 Assemblable in 15 minutes

 Fits into an estate car

 Tool-free assembly

PROMOTIONAL POINT SKETCH

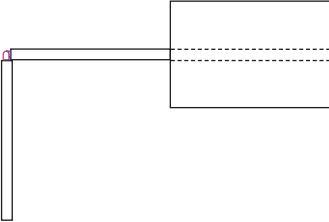

CONFIGURATION — 22

TECHNICAL INFO

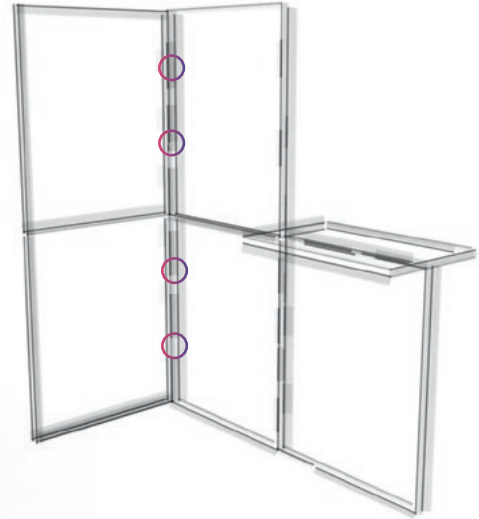

PROMO 1 FEATURES



Assemblable by
one person



Reusable



Assemblable in
15 minutes



Fits into an
estate car



Tool-free assembly

PROMOTIONAL POINT SKETCH

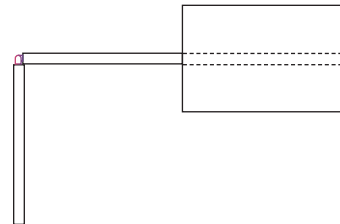

CONFIGURATION — 23

TECHNICAL INFO

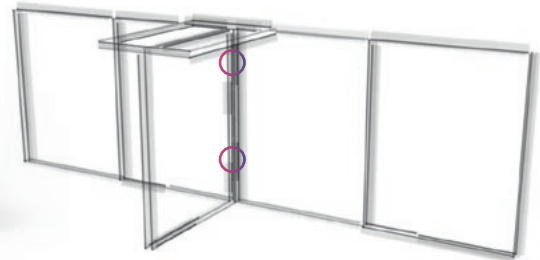

PROMO 1 FEATURES



Assemblable by one person



Reusable



Assemblable in 15 minutes



Fits into an estate car



Tool-free assembly

PROMOTIONAL POINT SKETCH

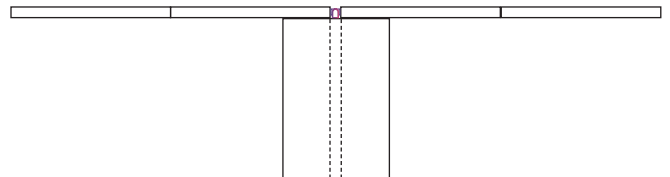

CONFIGURATION — 24

TECHNICAL INFO

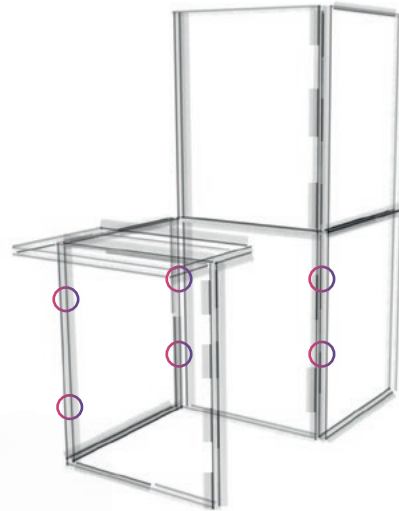

PROMO 1 FEATURES



Assemblable by one person



Reusable



Assemblable in 15 minutes



Fits into an estate car



Tool-free assembly

PROMOTIONAL POINT SKETCH

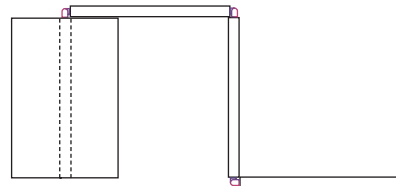

PROMO 1[®]

5-year guarantee

for construction elements. Graphic panels covered for 12 months.



www.marrow.fi

The Clever Frame System is a product registered with the Patent Office. Any copying of all or parts of the system is prohibited.
© 2010 Clever Frame International. All rights reserved.