

Modulate™ Straight 824

MOD-S-824

Modulate™ consists of a set of frames made from aluminium tubes (Ø30 mm) covered with a printed tension fabric graphic. These frames can be connected together using powerful magnets inside each frame. Modulate range is available in 11 different sized formats.

- Thanks to the exclusive **MagLink** magnetic system built into the structure, you can connect the frames by simply touching them together.
- With the **Twist & Lock** system, simply position the foot under the structure, turn it and it's locked!
- The graphics are very easy to maintain thanks to the crease-resistant and machine washable textile cover. Stretch fabric with zip system.



360° MagLink connector in each pole. 4 magnets per structure



400 mm extension included



Self-locking system with bungee poles and push-buttons



Simple assembly with numbered frame parts



Central reinforcement tube (Ø 18 mm)



2 stabilising feet with Twist & Lock supplied with each frame



Double-sided tension fabric. Zip system



Modulate™ carry bag with dedicated compartments for the feet and graphics



Structure informations :	
Item	Modulate Straight 824
Code	MOD-S-824
Structure dimensions	818 (w) x 2400 (h) x 400 (d) mm
Graphic visual area	800 (w) x 2382 (h) mm
Boxed dimensions (2 boxes)	1000 (w) x 245 (h) x 125 (d) + 460 (w) x 65 (h) x 65 (d) mm
Structure weight	6.78 kg
Boxed weight (2 boxes)	7.16 kg

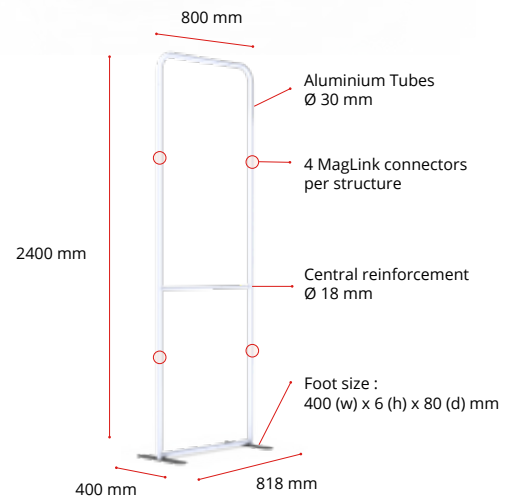

OPTIONAL ELEMENTS :



Modulate half feet (pair)
MOD-HALF-FOOT-P
218 (w) x 6 (h) x 80 (d) mm



Spot LED Flood
LED-FLOOD-ARM-BDLK



Spot LED Strip
LED-STRIP-ARM-BDLK



Universal light fitting kit
US901-C

MIX & MATCH THE 11 MODULATE FRAMES :

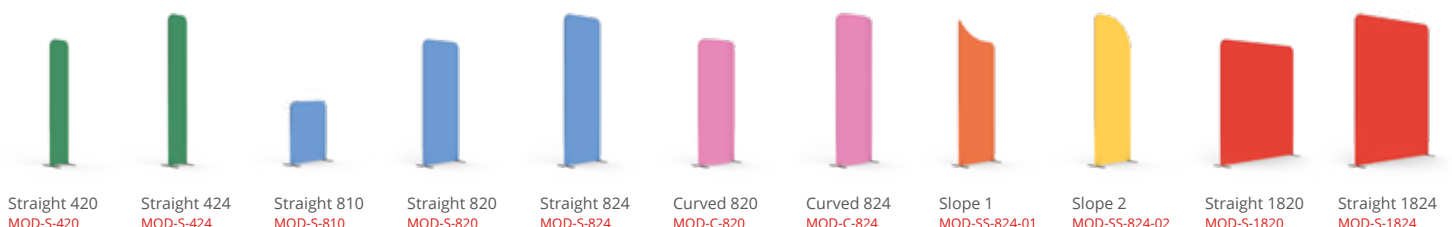

Modulate™ Straight 824

MOD-S-824



ELEMENTS

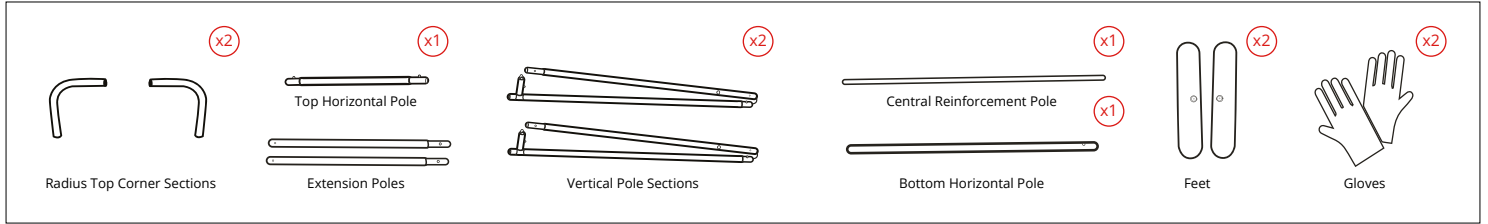

ASSEMBLY

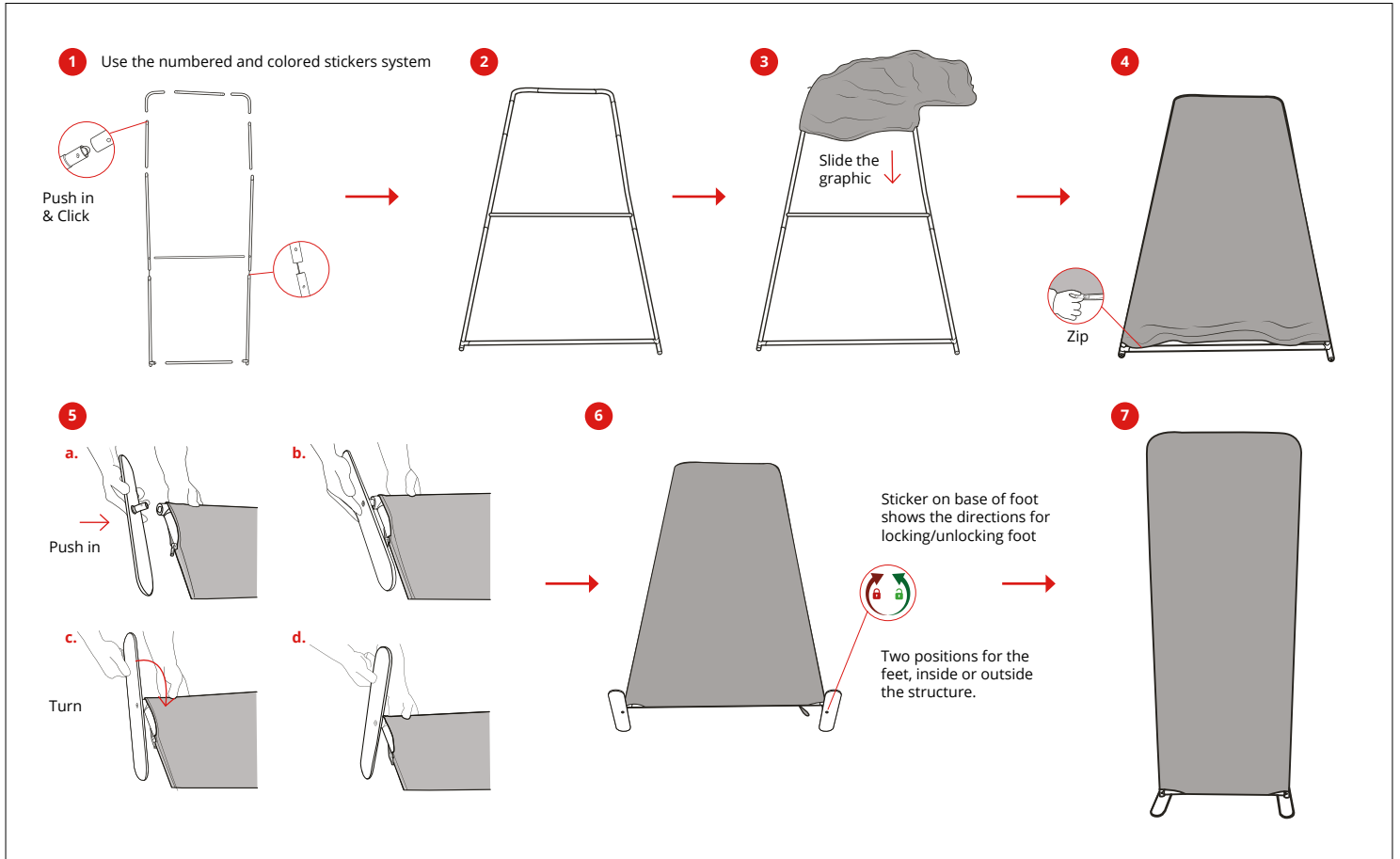

RECONFIGURABLE HEIGHT 2400 MM → 2000 MM

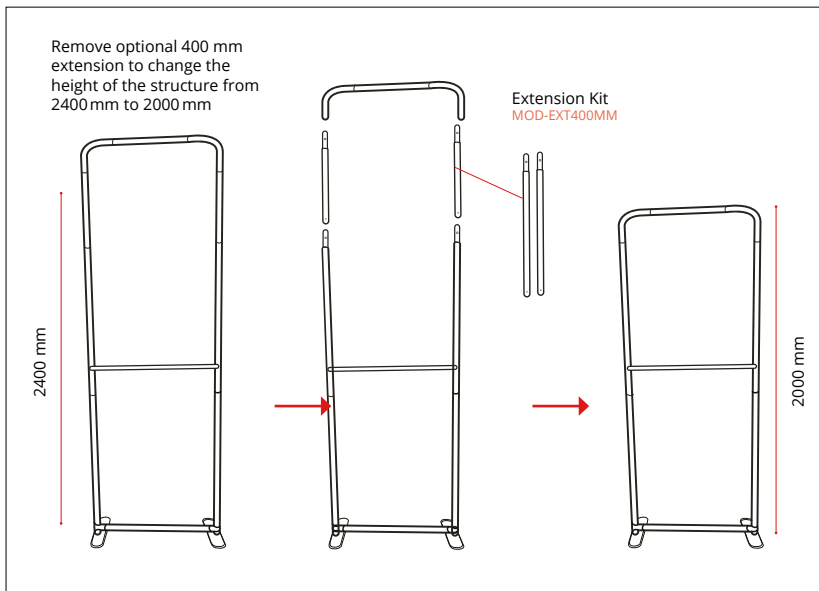

CONNECTING MULTIPLE FRAMES

Remove one foot from second frame and align both frames on one foot

